

# 680 SERIES

Hawthorne™ • Hartford™



OWNER'S MANUAL

6530-681, Rev. B

**Sundance® Spas**

# Attention New Spa Owner!

Congratulations on the purchase of your new Sundance® 680 series spa! The following is a list of automated functions and maintenance recommendations for your new spa. Automated functions have been listed below in an attempt to suppress any operational concerns you may have during startup and the first 24-hours of ownership! Maintenance recommendations are listed in an attempt to stress their importance in protecting your new spa.

## Automated Operations

Approximately two minutes after power is applied to the spa, the first filtration/heating cycle turns on pump 1. An automatic five minute “blow-out” function also activates pump 2 for a period of five minutes to flush all lines. Then, after five minutes, pump 2 turns off and pump 1 continues to operate for the duration of the cycle. *Note: this function only occurs during the first filtration/heating cycle each day.*

## Maintain Healthy Spa Water

Always maintain your spa’s water chemistry within the following parameters as defined by the Association of Pool And Spa Professionals/USA:

<b>pH</b>	<b>7.4-7.6</b>
<b>Free Chlorine</b>	<b>3.0-4.0 ppm</b>
<b>Free Bromine</b>	<b>2.0-4.0 ppm</b>
<b>Total Alkalinity</b>	<b>100-120 ppm</b>
<b>Calcium Hardness</b>	<b>150-250 ppm</b>

*Always maintain your spa filter as outlined below to ensure healthy spa water. Refer to pages 29-30 for additional information.*

## Required Filter Maintenance

Your new spa is equipped with an advanced water filtration system that provides unsurpassed water quality! To ensure maximum water quality at all times, you should clean and reuse both filter cartridges every month. See page 25 for detailed filter cleaning/replacement instructions.

## Required Water Maintenance

You should replace the spa’s water every 3 months. The frequency depends on a number of variables including frequency of use, number of users, and attention paid to water quality maintenance. You will know it is time for a change when you cannot control sudsing and/or you can no longer get the normal feel or sparkle to the water, even though the key water balance measurements are all within the proper parameters. See pages 29-30 for additional information.



## Table of Contents

<b>1.0</b>	<b>Important Spa Owner Information .....</b>	<b>1</b>
<b>2.0</b>	<b>FCC Notice .....</b>	<b>1</b>
<b>3.0</b>	<b>Important Safety Instructions .....</b>	<b>2</b>
3.1	Important CSA Safety Instructions (Canada only).....	4
3.2	Hyperthermia.....	5
3.3	Cautions .....	6
3.4	General Electrical Safety Instructions .....	6
<b>4.0</b>	<b>Choosing A Location .....</b>	<b>7</b>
4.1	Outdoor Location.....	7
4.2	Indoor Location.....	8
<b>5.0</b>	<b>Power Requirements.....</b>	<b>9</b>
<b>6.0</b>	<b>Electrical Wiring Instructions.....</b>	<b>10</b>
<b>7.0</b>	<b>Spa Fill Up Procedure .....</b>	<b>11</b>
<b>8.0</b>	<b>Control Functions .....</b>	<b>17</b>
8.1	Control Panel.....	17
8.2	General Spa Features And Controls .....	18
<b>9.0</b>	<b>Operating Instructions.....</b>	<b>19</b>
9.1	Setting Water Temperature .....	19
9.2	Activate Pumps .....	19
9.3	Standard Light Operation .....	19
9.4	Optional Multi-Colored LED Light System Operation .....	20
9.5	Adjusting Individual Jet Flow .....	21
9.6	Selecting Desired Massage Action.....	21
9.7	Air Controls.....	21
<b>10.0</b>	<b>Automatic Filtration Cycles.....</b>	<b>21</b>
10.1	Standard Filtration/Heating Modes For Spas <u>Without</u> Circulation Pump Option .....	22
10.2	Standard Filtration/Heating Modes For Spas <u>With</u> Circulation Pump Option .....	22
10.3	Economy Filtration/Heating Modes (All Models) .....	22
10.4	Lock Modes - All Models (L1 - L2).....	22
10.5	Selecting The Filtration/Heating Mode .....	22
10.6	Filtration Modes for Spas Without Circulation Pump Option .....	23
10.7	Filtration Modes for Spas With Circulation Pump Option .....	24



<b>11.0</b>	<b>Spa Maintenance</b> .....	<b>25</b>
11.1	Cleaning The Filter Cartridges .....	25
11.2	Draining and Refilling .....	26
11.3	Pillow Care .....	27
11.4	Cleaning The Spa Interior .....	27
11.5	Maintaining the Cover .....	27
11.6	Maintaining The Synthetic Cabinet.....	27
11.7	Winterizing.....	28
11.8	Restarting Your Spa in Cold Weather.....	28
<b>12.0</b>	<b>Water Quality Maintenance</b> .....	<b>29</b>
12.1	pH Control .....	29
12.2	Sanitizing.....	29
12.3	Optional CD Ozone Water Maintenance System .....	30
<b>13.0</b>	<b>Error Conditions / Error Messages</b> .....	<b>30</b>
13.1	Summer Logic (Spas With Circulation Pump Option) .....	30
13.2	Panel Displays OH .....	30
13.3	Panel displays COL.....	30
13.4	Panel displays SN1 .....	31
13.5	Panel displays SN2 .....	31
13.6	Panel Flashes FL1 or FL2 (Spas Without Circulation Pump Option) .....	31
13.7	Panel Flashes FL1 or FL2 (Spas With Circulation Pump Option) .....	31
13.8	Panel Displays ICE.....	32
13.9	Panel displays - - -.....	32
<b>14.0</b>	<b>Troubleshooting Procedures</b> .....	<b>32</b>
14.1	None Of The Components Operate (e.g. Pump, Light).....	32
14.2	Pump Does Not Operate But Light Does .....	32
14.3	Poor Jet Action .....	33
14.4	Water Is Too Hot.....	33
14.5	No Heat .....	33
<b>15.0</b>	<b>Circuit Diagram For Models Without Circulation Pump Option</b> .....	<b>34</b>
<b>16.0</b>	<b>Circuit Diagram For Models With Circulation Pump Option</b> .....	<b>35</b>
<b>17.0</b>	<b>Optional SunSound™ Stereo Receiver Functions</b> .....	<b>36</b>



## 1.0 Important Spa Owner Information

Your Sundance® 680 series spa is constructed to the highest standards and is capable of providing many years of trouble-free use. However, because heat retentive materials are utilized to insulate the spa for efficient operation, an uncovered spa surface and wall fittings directly exposed to sunlight and high temperatures for an extended period is subject to permanent damage or discoloration. Damage caused by exposing the spa to this abuse is not covered under warranty. We recommend that you always keep the spa full of water when it is exposed to direct sunlight and that you keep the Sundance premium insulating cover in place at all times when the spa is not in use. Read and carefully follow the requirements for your spa's support base found in section 4.0 titled, "Choosing a Location" (page 7).

**Sundance constantly strives to offer the finest spas available, therefore modifications and enhancements may be made which affect the specifications, illustrations and/or instructions contained herein.**

## 2.0 FCC Notice

This equipment has been tested and found to comply with the limits for a Class B Digital Device, pursuant to Part 15 of the FCC Rules. These limits are designed to provide reasonable protection against harmful interference in a residential installation. This equipment generates, uses and can radiate radio frequency energy and, if not installed and used in accordance with the instructions, may cause harmful interference to radio communications. However, there is no guarantee that interference will not occur in a particular installation. If this equipment does cause harmful interference to radio or television reception, which can be determined by turning the equipment off and on, the user is encouraged to try to correct the interference by one or more of the following measures:

1. Rearrange or relocate the receiving antenna.
2. Increase the separation between the equipment and receiver
3. Connect the equipment into an outlet on a circuit different from the circuit connected.
4. Consult the dealer or an experienced radio/TV technician for help. Changes or modifications not expressly approved by the party responsible for FCC compliance could void the user's authority to operate this equipment.



### 3.0 Important Safety Instructions

#### **READ AND FOLLOW ALL INSTRUCTIONS CAREFULLY!**

When installing and using this electrical equipment, basic safety precautions should always be followed, including:

1. **WARNING:** To reduce the risk of injury, do not permit children to use this product unless they are closely supervised at all times.
2. **WARNING:** A grounding wire connector is provided on this unit to connect a minimum No. 8 AWG (8.4mm<sup>2</sup>) solid copper conductor between this unit and any metal equipment, metal enclosures of electrical equipment, metal water pipe, or conduit within 5 feet (1.5m) of the unit.
3. **DANGER:** *Risk of Accidental Drowning.* Extreme caution must be exercised to prevent unauthorized access by children. To avoid accidents, ensure that children cannot use this spa unless they are supervised at all times.
4. **DANGER:** *Risk of Injury.* The suction fittings in this spa are sized to match the specific water flow created by the pump. Should the need arise to replace the suction fittings or the pump, be sure that the flow rates are compatible. Never operate the spa if the suction fittings are broken or missing. Never replace a suction fitting with one rated less than the flow rate marked on the original suction fitting.
5. **DANGER:** *Risk of Electric Shock.* Install at least 5 feet (1.5m) from all metal surfaces. As an alternative, a spa may be installed within 5 feet (1.5m) of metal surfaces if each metal surface is permanently connected (bonded) by a minimum No. 8 AWG (8.4mm<sup>2</sup>) solid copper conductor attached to the wire connector on the grounding lug, inside the equipment compartment on the equipment box.
6. **DANGER:** *Risk of Electric Shock.* Do not permit any electrical appliance, such as a light, telephone, radio, television, etc. within 5 feet (1.5m) of a spa, unless such appliances are built-in by the manufacturer.
7. **ELECTRICAL SUPPLY:** The electrical supply for this product must include a suitably rated switch or circuit breaker to open all ungrounded supply conductors to comply with section 422-20 of the



National Electrical Code/USA, ANSI/NFPA 70. The disconnect must be readily accessible and visible to the spa occupant but installed at least 5 feet (1.5m) from the spa water.

8. **WARNING:** To Reduce the Risk of Injury:
9. The water in a spa should never exceed 104°F (40°C). Water temperatures between 100°F (38°C) and 104°F (40°C) are considered safe for a healthy adult. Lower water temperatures are recommended for young children and when spa use exceeds 10 minutes.
10. Since excessive water temperatures have a high potential for causing fetal damage during the early months of pregnancy, pregnant or possibly pregnant women should limit spa water temperatures to 100°F (38°C). If pregnant, please consult your physician before using a spa.
11. Before entering the spa, the user should measure the water temperature with an accurate thermometer since the tolerance of water temperature-regulating devices may vary as much as +/- 5°F (2°C).
12. The use of alcohol, drugs, or medication before or during spa use may lead to unconsciousness with the possibility of drowning.
13. Persons suffering from obesity or a medical history of heart disease, low or high blood pressure, circulatory system problems, diabetes, infectious diseases or immune deficiency syndromes should consult a physician before using a spa. If you experience breathing difficulties in association with using or operating your spa, discontinue use and consult your physician.
14. Persons using medication should consult a physician before using a spa since some medication may induce drowsiness, while other medication may affect heart rate, blood pressure, and circulation.
15. Always shower before and after using your spa. To reduce the possibility of contracting a waterborne illness, always maintain water chemistry within the parameters listed on the inside cover of this manual. If you or other bathers experience such a condition, discontinue use and seek medical attention.



### **3.1 Important CSA Safety Instructions (Canada only)**

When using this electrical equipment, basic safety precautions should always be followed, including the following:

#### **1. READ AND FOLLOW ALL INSTRUCTIONS.**

2. A green colored terminal or a terminal marked G, Gr, Ground, Grounding or the ⊖ symbol\* is located inside the supply terminal box or compartment. To reduce the risk of electric shock, this terminal must be connected to the grounding means provided in the electric supply service panel with a continuous copper wire equivalent in size to the circuit conductors that supply this equipment (\*IEC Publication 417, Symbol 5019).
3. At least two lugs marked “Bonding Lugs” are provided on the external surface or on the inside of the supply terminal box/ compartment. To reduce the risk of electric shock, connect the local common bonding grid in the area of the spa to these terminals with an insulated or bare copper conductor not smaller than No. 6 AWG (10mm<sup>2</sup>).
4. All field-installed metal components such as rails, ladders, drains or other similar hardware within 10 feet (3m) of the spa shall be bonded to the equipment grounding buss with copper conductors not smaller than No. 6 AWG (10mm<sup>2</sup>).

#### **5. SAVE THESE INSTRUCTIONS**

**WARNING:** Children should not use spas without adult supervision.

**WARNING:** Do not use spas unless all suction guards are installed to prevent body and hair entrapment.

**WARNING:** People with infectious diseases should not use a spa.

**WARNING:** To avoid injury, exercise care when entering or exiting the spa.

**WARNING:** Do not use drugs or alcohol before or during the use of a spa to avoid unconsciousness and possible drowning.



**WARNING:** Pregnant or possibly pregnant women should consult a physician before using a spa.

**WARNING:** Water temperature in excess of 38°C (104°F) may be injurious to your health.

**WARNING:** Before entering the spa, measure the water temperature with an accurate thermometer.

**WARNING:** Do not use a spa immediately following strenuous exercise.

**WARNING:** Prolonged immersion in a spa may be injurious to your health.

**WARNING:** Do not permit electric appliances (such as light, telephone, radio, television, etc.) within 5 feet (1.5m) of this spa unless factory installed.

**CAUTION:** Maintain water chemistry in accordance with manufacturer's instructions.

**WARNING:** The use of alcohol or drugs can greatly increase the risk of fatal hyperthermia in spas.

### 3.2 Hyperthermia

Prolonged immersion in hot water may induce hyperthermia. A description of the causes, symptoms, and effects of hyperthermia are as follows:

Hyperthermia occurs when the internal temperature of the body reaches a level several degrees above the normal body temperature of 98.6°F (37°C). The symptoms of hyperthermia include drowsiness, lethargy, and an increase in the internal temperature of the body. The effects of hyperthermia include:

- A. Unawareness of impending hazard;
- B. Failure to perceive heat;
- C. Failure to recognize the need to exit spa;
- D. Physical inability to exit spa;
- E. Fetal damage in pregnant women; and
- F. Unconsciousness and danger of drowning.



### 3.3 Cautions

1. Persons suffering from heart disease, diabetes, high or low blood pressure, and any condition requiring medical treatment, pregnant women, the elderly, or infants should consult with a physician before using a spa.
2. The Consumer Products Safety Commission/USA has stated that the water temperature in a spa should not exceed 104°F (40°C). Immersion in water in excess of 104°F (40°C) can be hazardous to your health.
3. Observe a reasonable time limit when using the spa. Long exposures at higher temperatures can cause high body temperature. Symptoms may include dizziness, nausea, fainting, drowsiness, and reduced awareness. These effects could possibly result in drowning.
4. Do not use the spa under the influence of alcohol, narcotics, or other drugs. Use of the spa under these conditions may lead to serious consequences.
5. Always test the spa water temperature before entering the spa. Enter and exit the spa slowly. Wet surfaces can be very slippery.
6. Never bring any electrical appliances into or near the spa. Never operate any electrical appliances from inside the spa or when you are wet unless such appliances are built-in by the manufacturer.
7. Proper chemical maintenance of spa water is necessary to maintain safe water and prevent possible damage to spa components.
8. Use the straps and clip tie downs to secure the cover when not in use. This will help to discourage unsupervised children from entering the spa and keep the spa cover secure in high-wind conditions. There is no representation that the cover, clip tie-downs, or actual locks will prevent access to the spa.

### 3.4 General Electrical Safety Instructions

Your new Sundance® spa is equipped with a “state-of-the-art” equipment system. It contains the most advanced safety and self-protective equipment in the industry. Nonetheless, this spa must be installed properly to ensure dependable usage. Please contact your local Sundance dealer or local building department should you have any questions regarding your installation.

Proper grounding is extremely important. Sundance spas are equipped with a current collector system. A pressure wire connector is provided on the surface of the control box, located outside the equipment door (Figure-B, page 11) to permit connection of a bonding wire between this point and any ground metal equipment, metal water pipe or conduit



within 5 feet (1.5m) of the spa, or copper clad grounding rod buried within 5 feet (1.5m) of the spa. Bonding wire must be at least No. 8 AWG (8.4mm<sup>2</sup>) solid copper wire. This is a most important safety assurance feature.

Before installing your spa, check with your local building department to insure installation conforms to local building codes.

## 4.0 Choosing A Location

**IMPORTANT:** Because of the combined weight of the spa, water and users, it is extremely important that the base upon which the spa rests be smooth, flat, level and capable of uniformly supporting this weight, without shifting or settling, for the entire time the spa is in place. If the spa is placed on a surface which does not meet these requirements, damage to the skirt and/or the spa shell may result. Damage caused by improper support is not covered under warranty. It is the responsibility of the spa owner to assure the integrity of the support over time. We recommend a poured, reinforced concrete slab with a minimum thickness of 4 inches (10cm). Wood decking is also acceptable provided it is constructed so that it meets the requirements outlined above.

The spa must be installed in such a manner as to provide drainage away from it. Placing the spa in a depression without provisions for proper drainage could allow rain, overflow and other casual water to flood the equipment and create a wet condition in which it would sit in. For spas which will be recessed into a floor or deck, install so as to permit access to the equipment, either from above or below, for servicing. Make certain that there are no obstructions which would prevent removal of all side cabinet panels and access to the jets components, especially on the side with the equipment bay.

### 4.1 Outdoor Location

In selecting the ideal outdoor location for your spa, we suggest that you take into consideration the following:

- The proximity to changing area and shelter (especially in regions subject to cold weather).
- The pathway to and from your spa (this should be free of debris so that dirt and leaves are not easily tracked into the spa).



- The closeness to trees and shrubbery (remember that leaves and birds could create extra work in keeping the spa clean).
- A sheltered environment (less wind and weather exposure can result in lower operation and maintenance costs).
- The overall enhancement of your environment. It is preferable not to place the spa under an unuttered roof overhang since run-off water will shorten the life expectancy of the spa cover.

## 4.2 Indoor Location

For indoor installations many factors need to be considered before installing a spa indoors:

- **PROPER FOUNDATION:** Consult a Structural Engineer when considering a foundation that will adequately support the spa the entire time it is in place. Proper support is critical especially if the spa is to rest on a second story or higher. For spas that are to rest on balconies, roofs or other platforms not specifically tied into the main structural support, you should consult a professional Structural Engineer with experience in this type of application.
- **PROPER DRAINAGE:** It is extremely important to have in place measures to sufficiently handle excessive water spillage. Be sure the flooring in which the spa rests on has adequate drainage and can handle draining of the entire contents of the spa. Be sure to make provisions for ceilings or any other structures that may be below the spas installation. Areas around your spa can become wet or moist so all flooring and subsequent furniture, walls and adjacent structures should be able to withstand or resist water and moisture.
- **PROPER VENTILATION:** Proper ventilation should be discussed with an Engineer or authority competent enough to understand the necessary provisions needed to vent moist or heated air and air associated with chemical odors outdoors. When the spa is in use considerable amounts of moisture will escape potentially causing mold and mildew, over time this can damage certain surfaces and or surroundings.
- **SUFFICIENT ACCESS:** In the unlikely event that you should ever need to access or gain entry to any portion of the spa for servicing, it is highly recommended that you plan your indoor installation to provide full access to the entire spa.



- **WARRANTY:** Damage caused by not following these guidelines or any improper installation not in accordance with local codes or authorities is not covered under the spas warranty. Please consult your local state or city building ordinances.



**WARNING:** In addition to maintenance of filters and water chemistry, proper ventilation is recommended to reduce the risk of exposure to viruses and bacteria that could be present in the air or water. Consult a licensed architect or building contractor to determine your specific needs if installing your spa indoors.

## 5.0 Power Requirements

Sundance® spas are designed to provide optimum performance and flexibility of use when connected to the maximum electrical service listed on page 10-11. Minor circuit board modifications can be performed to allow your new spa to accept an electrical service other than the factory 50 Amp operation setting. *Note: Refer to pages 34-35 for circuit board configuration details or contact your authorized Sundance dealer.*

### All Models (60Hz)

	240V/40A*	240V/50A**	240V/60A***
Voltage:	240 VAC	240 VAC	240 VAC
# of Wires:	3	3	3
Frequency:	60Hz	60Hz	60Hz
Current Draw:	26A	36A	45A
Circuit Breaker:	40A, 2-Pole	50A, 2-Pole	60A, 2-Pole

\* In 40A configuration, the heater **will not operate** while either jets pump is running in high speed. *Note: pump 2 runs only in high speed.*

\*\* In 50A configuration, the heater **will not operate** while both jets pumps are running in high speed. *Note: pump 2 runs only in high speed. **This is the factory setting.***

\*\*\* In 60A configuration, the heater **will operate** while both jets pumps are running in high speed. *Note: pump 2 runs only in high speed.*



## 6.0 Electrical Wiring Instructions

**IMPORTANT NOTICE:** The electrical wiring of this spa must meet the requirements of the National Electrical Code/USA (NEC) and any applicable state or local codes. The electrical circuit must be installed by a qualified electrician and approved by a local building/electrical inspection authority.

1. This spa must be permanently connected (hard-wired) to the power supply. **No plug-in connections or extension cords are to be used in conjunction with the operation of this spa.** Supplying power to the spa which is not in accordance with these instructions will void both the independent testing agency listing and the manufacturer's warranty.
2. The power supplied to this spa *must be a dedicated circuit* with no other appliances or lights sharing the power provided by the circuit.
3. To determine the current, voltage and wire size required, refer to section 5.0 "Power Requirements" (page 9).
  - Wire size must be appropriate per NEC and/or local codes.
  - We recommend type THHN wire.
  - All wiring must be copper to ensure proper connections. **Do not use aluminum wire.**
  - When using wire larger than #6 (10mm<sup>2</sup>), add a junction box near the spa and reduce to short lengths of #8 (8.4mm<sup>2</sup>) wire to connect to the spa.
4. The electrical supply for this product must include a suitably rated switch or circuit breaker to open all ungrounded supply conductors to comply with section 422-20 of the National Electrical Code/USA, ANSI/NFPA 70. The disconnecting means must be readily accessible to the spa's occupant but installed at least 5 feet (1.5m) from spa water.
5. The electrical circuit supplied for the spa must include a suitable ground fault circuit interruptor (GFCI) as required by NEC Article 680-42.
6. To gain access to the spa's power terminal block, remove the screws securing the cabinet panel on the side of the spa under the control panel (Figure A). Then remove the four control box door screws and door (Figure-B).



7. Select the power supply inlet you want to use (Figure-A). Feed power cable to control box, then install it through the large opening provided in the bottom side of the box.
8. Connect wires, color to color, on terminal blocks TB1 and TB3 (Figure C, page 12). TIGHTEN SECURELY! All wires must be hooked up securely or damage could result.
9. Install control box door and screws and reinstall the cabinet side panels.

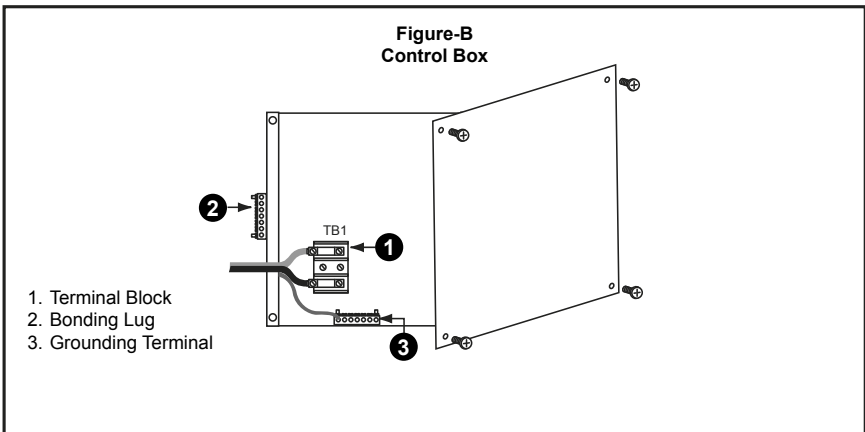
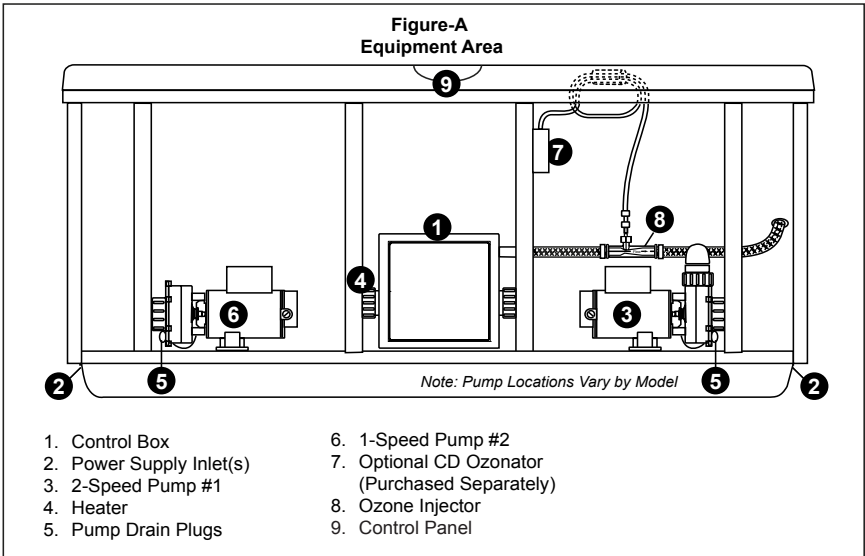



**Figure-C**  
**Main TB1 And TB3 Terminal Block Connections**

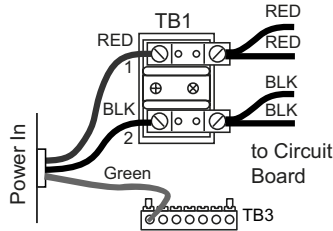

**All North American Models:**  
**240 VAC, 3-Wire Connection (60Hz)**

## 7.0 Spa Fill Up Procedure

FOR BEST RESULTS, READ EACH STEP IN ITS ENTIRETY BEFORE PROCEEDING WITH THAT STEP.

### 1. Prepare The Spa For Filling

- Clear all debris from the spa. (Although the spa shell has been polished at the factory, you may want to treat it with a specially formulated spa cleaner. Consult your authorized Sundance dealer for additional information prior to filling spa.)
- Remove filter/skimmer lid, then remove filter cartridge as outlined in section 11.1 (page 25).

### 2. Fill Spa

- Place the end of your garden hose into the empty filter bucket.



**CAUTION:** Never fill with water from a water softener. If your water is extremely “hard”, it is preferable to fill half-way with hard water and the rest of the way with softened water. Or, you may fill entirely with hard water if you use a special water additive available from your authorized Sundance dealer.

- Fill spa with clean tap water from garden hose until water covers all jets. **DO NOT OVERFILL!**



**IMPORTANT:** Always fill your spa through the filter bucket after draining. Failure to do so may cause air to be trapped in either pump, preventing the pump from circulating water. Remove the hose and replace the filter cartridge. **DO NOT OVERTIGHTEN! FINGER TIGHT ONLY!**

### 3. Turn On Power

Turn on power to spa at the home's circuit breaker to start boot up sequence (sec. 9.0, page 19). The heater and filter pump will automatically activate after several seconds. If the control panel LED flashes water temperature and "COOL" or "ICE" this is normal, refer to pages 30-32 for additional information.

### 4. Activate Jets Pumps

Turn on all jet(s) pumps to ensure proper mixing when adding start-up chemical in step 5.

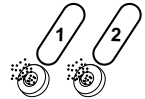

### 5. Add Start-Up Chemicals

Add the spa water chemicals as recommended by your authorized Sundance dealer. See section titled "WATER QUALITY MAINTENANCE" (page 29) for general guidance.

### 6. Establish A Stable Sanitizer Reading

Establish a stable sanitizer reading between 3.0-4.0 ppm chlorine or 2.0-4.0 ppm bromine. To ensure healthy water conditions, always maintain a constant sanitizer reading within the levels recommended by the Association of Pool And Spa Professionals/USA printed on the inside cover of this manual. If sanitizer levels cannot be stabilized, perform the decontamination procedure steps 9-15 on the following page. *Note: the "decontamination procedure" steps 9-15 should also be used after the spa has been "Winterized" (sec. 11.7, page 28) or has been sitting without power for an extended period.*

### 7. Set Spa To Heat

To warm spa water to a comfortable temperature, follow these steps:



- The LED display on the control panel displays the actual temperature of the spa water. Press either the COOLER (-) or WARMER (+) button once to display the "set" temperature for 5 seconds. If you want the water to heat to a different temperature, simply press COOLER (-) or WARMER (+) within 5 seconds. The set temperature



increases or decreases by one degree each time one of these buttons is pressed.

- The heater will turn off when the temperature corresponding to the thermostat setting is achieved.

#### **Important Heater Details:**

- The maximum temperature for which the spa can be set is 104°F (40°C) and the minimum is 65°F (18°C).
- For spas connected to a 40 amp service, jets pump #1 must be set to low speed and jets pump #2 must be turned off to operate the heater.
- Setting the thermostat at maximum will not accelerate the heating process. This will only result in a higher ultimate temperature.
- The heater operates until the water reaches the programmed “set temperature”, then turns off. The heater will reactivate after the water cools to approximately 1.5° below the “set temperature.”

### **8. Place Cover On Spa**

- Keeping the insulating cover in place anytime the spa is not in use will reduce the time required for heating, thereby minimizing operating costs.
- The time required for initial heat-up will vary depending on the starting water temperature.



**DANGER:** Risk of injury, always check water temperature carefully before entering spa!

### **Decontamination Procedure (Steps 9-15)**

Steps 9-15 below are only required when sanitizer levels are unstable after performing steps 1-6 above. Disregard steps 9-15 below if sanitizer levels remain stable at 3.0-4.0 ppm chlorine or 2.0-4.0 ppm bromine after performing steps 1-6 above.

9. Add 2.5 ounces of sodium dichlor for every 100 gallons of water. Refer to the table below for approximate water fill volume by model.



**CAUTION:** Never add chlorine tablets (trichlor) to your spa for any reason! This chemical may damage components within your spa and void the manufacturer warranty.



### Water Fill Volume by Model

Spa Model	Approximate Fill Volume	Sodium Dichlor
Hawthorne .....	400 US Gallons (1,514 Liters).....	10 oz.
Hartford.....	340 US Gallons (1,287 Liters).....	8.5 oz.

10. Leave spa cover open during this step to allow excessive chemical vapors to exit spa, protecting plastic knobs and pillows from chemical attack. If spa is indoors, open doors and windows for proper ventilation. Turn on all jets pumps for one hour, then place the massage selector knob in the center “combo” position and open all air controls. *Note: You will need to press the jets pump button(s) every 20 minutes since these functions have an automatic 20 minute time-out function that turns them off.*

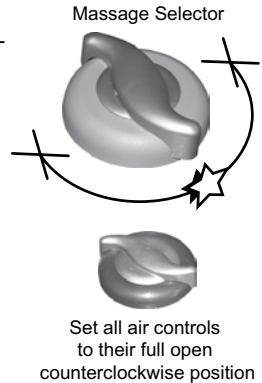



**CAUTION:** Never leave your spa unattended for any reason while the cover is open and accessible to small children and animals!

11. Turn off power to the spa at the circuit breaker, then drain spa as outlined in section 11.2 (page 26).
12. Refill spa with clean tap water from garden hose until water covers all jets. **DO NOT OVERFILL!**



**CAUTION:** Never fill with water from a water softener. If your water is extremely “hard”, it is preferable to fill half-way with hard water and the rest of the way with softened water. Or, you may fill entirely with hard water if you use a special water additive available from your authorized Sundance dealer.

13. Consult your authorized Sundance dealer for chemical recommendations, then add chemicals to spa water to achieve a constant sanitizer reading within the levels recommended by the Association of Pool And Spa Professionals/USA printed on the inside cover of this manual.
14. Turn on all jet pumps when adding chemicals to ensure proper mixing and leave your spa cover open until the sanitizer level falls below 4.0 ppm to protect plastic knobs and pillows from chemical attack.



**CAUTION:** Never leave your spa unattended for any reason while the cover is open and accessible to small children and animals.



**CAUTION:** To prevent the unlikely possibility of contracting a waterborne illness, maintain water chemistry within step 6 parameters. If you or other bathers experience such a condition, discontinue use and seek medical attention.

15. Establish a sanitizer reading between 3.0-4.0 ppm chlorine or 2.0-4.0 ppm bromine, then allow the spa to set undisturbed for 8 hours. Retest water after 8 hours to determine if sanitizer levels are stable. If sanitizer levels are stable, your spa is ready for use. To ensure healthy water conditions, always maintain a constant sanitizer reading within the levels recommended by the Association of Pool And Spa Professionals/USA printed on the inside cover of this manual. If sanitizer levels are not stable at this time, it will be necessary to repeat this procedure in its entirety (steps 1-15) until stable sanitizer readings are achieved.
16. After adequate sanitizer levels are achieved, close all spa air controls by rotating them clockwise to maximize heat retention when spa is not in use.



## 8.0 Control Functions

### 8.1 Control Panel

A. LED Display: Can display current water temperature (default display), water temperature set point, selected filtration/heating mode, and error messages.

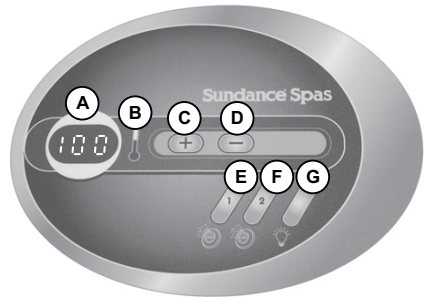

B. Heat Indicator: Lit when heater is on.

C. Warmer ( + ) Button: Increases water temperature set point.

D. Cooler ( - ) Button: Decreases water temperature set point.

E. Jets 1 Button: Turns jets pump #1 on and off. Press once for low speed; press a second time for high speed; press a third time to turn pump off.

F. Jets 2 Button: Turns jets pump #2 on and off. Press once for high speed; press a second time to turn pump off.

G. Light Button Options

- With standard Incandescent light: Turns underwater light on and off.
- With optional LED lighting system: Turns underwater light and top rim accent lights on in one of three random modes or one of seven solid colors. Refer to section 9.3 (page 20) for details.

### Operation Details

- Temperature Adjustment: 65-104°F (18-40°C). Factory default setting is 100°F (38°C).
- Standard light system: Incandescent light runs for 1 hour, then automatically shut off for increased bulb life.
- Optional LED light system: All LED lights run for 1 hour, then automatically shut off.
- Jets 1/Jets 2 Button Operation: Jets run for 20 minutes after activated, then turn off automatically to conserve energy. Simply press either jets button to continue operation for an additional 20 minutes.



## 8.2 General Spa Features And Controls

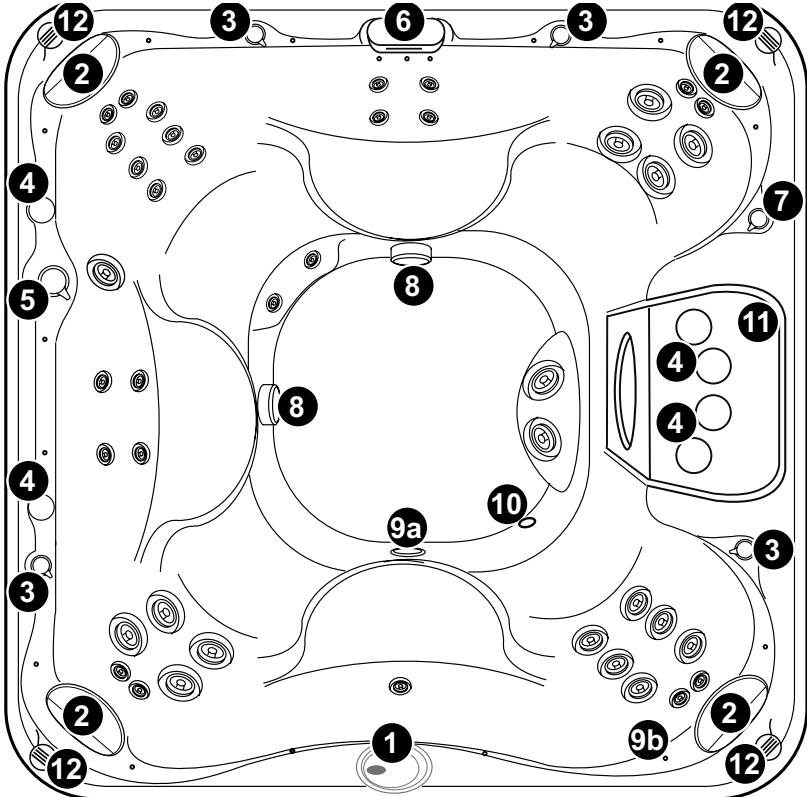

**12** ↑ *Hartford model illustrated - Jet locations and features will vary by model.*

1. Control Panel
2. Headrest Pillows (4 ea.)
3. Air Controls (4 ea.)
4. Cup Holders (6 ea.)
5. Massage Selector (1 ea.)
6. Waterfall
7. Waterfall control valve (1 ea.)
8. Suction Fittings (2 ea.)
9. Lighting System Options:
  - Standard Underwater light system includes incandescent light (9a).
  - Optional LED lighting system includes LED footwell light (9a) and multiple led accents lights (9b).
10. Gravity Drain: Fitting functions as floor gravity drain, heater return and optional CD ozone return.
11. Filter lid with four cup holders and two underlying filter cartridges.
  - Spas without the circulation pump option utilize both filter cartridges for jets pump 1.
  - Spas with the circulation pump option utilize one filter cartridge closest to waterfall valve (7) for jets pump 1 and the second cartridge for the 24-hour circulation pump.
12. Optional audio system speakers (4 ea.) and AM/FM/CD stereo deck (1 ea.) located on front spa skirt.

*Specifications Subject to Change Without Notice.*



## 9.0 Operating Instructions

The spa control system has automatic functions that operate upon start-up and normal operation to protect the system. Upon power up, the readout displays the following information:

1. Control panel displays current software release (3.56 or 5.55 depending on spa model) then;

Spas with Circulation Pump Option	Spas without Circulation Pump Option
-----------------------------------	--------------------------------------

2. Control panel displays “888” and all indicator LEDs are lit, permitting visual inspection of all display segments and indicator lights for proper operation.

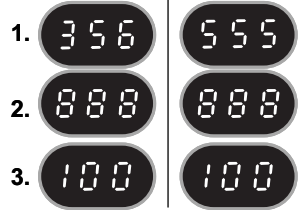

3. After the initial start-up sequence ends, the actual water temperature is displayed. If water temperature at this time is less than the factory default temperature setting of 100°F (38°C) and the spa is set to either standard filtration/heating mode (Sections 10.1-10.2, page 22), the heater will turn on and run until the water temperature rises to the factory setting, then turn off. *Note: it is common for the heater to turn on after the spa is first filled because tap water is often very cold.*

### 9.1 Setting Water Temperature

The spa's thermostat provides optimum control of water temperature. The temperature set point (set temperature) can be adjusted from 65-104°F (18-40°C). To raise the set temperature, press the WARMER (+) button. To lower the set temperature, press the COOLER (-) button. *Note: The first press of either WARMER (+) or COOLER (-) button displays the set temperature.*

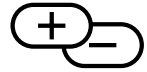

### 9.2 Activate Pumps

The control panel JETS 1 button activates jets pump 1. The first press activates low speed, the second press activates high speed, and the third press shuts jets pump 1 off. The JETS 2 button activates jets pump 2. The first press activates high speed, the second press turns jets pump 2 off. When manually activated, either pump will automatically turn off after 20 minutes.

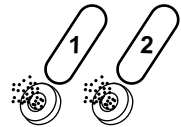

### 9.3 Standard Light Operation

The light button activates the footwell light in the spa when pressed. Pressing the button turns the footwell light off. When manually activated, the footwell light will automatically turn off after one hour.

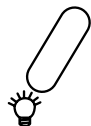



### 9.4 Optional Multi-Colored LED Light System Operation

The multi-colored LED spa light offers seven constant color variations and three unique random modes for enhanced spa enjoyment. Press the light button once to activate the first light mode “Random Fade”, then continue pressing the button to either turn the light off or to select one of seven constant colors, random solid color mode or strobe mode as illustrated below.

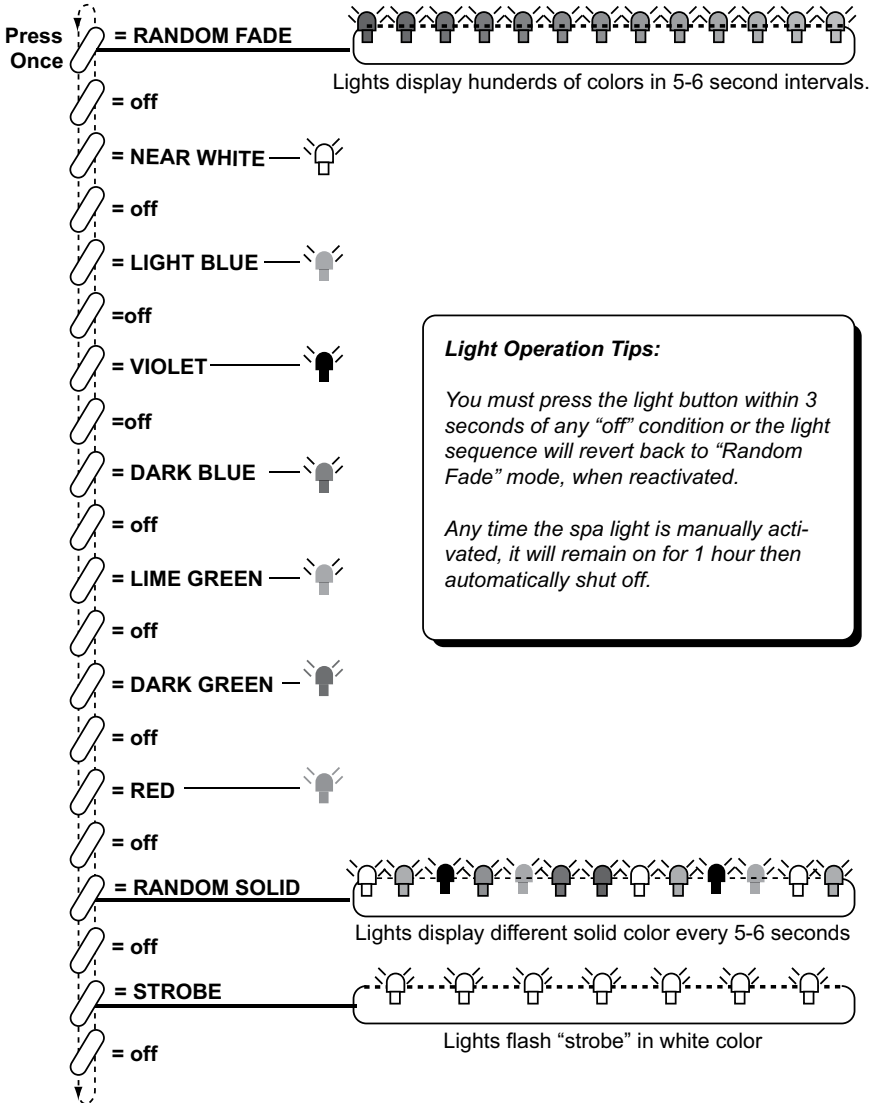
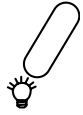

**Light Operation Tips:**

*You must press the light button within 3 seconds of any “off” condition or the light sequence will revert back to “Random Fade” mode, when reactivated.*

*Any time the spa light is manually activated, it will remain on for 1 hour then automatically shut off.*



### 9.5 Adjusting Individual Jet Flow

The water flow through individual jets in your spa can be adjusted or turned off by rotating the outside jet ring. Many jets also offer an adjustable center nozzle that allows you to change the water discharge angle. Simply tilt the center nozzle in these jets to the desired angle to customize your personal massage. *Note: Always keep at least 6 adjustable jets open at all times to ensure proper filtration characteristics within spa.*



### 9.6 Selecting Desired Massage Action

All models incorporate a massage selector valve that allows you to customize the massage and performance by diverting water between various jet systems within the spa. Simply turn valve to positions A, B or C to divert water pressure to various jet groups.

*Note: The valve is intended to operate in positions A (Combo), B, or C for optimum performance. It is considered normal for sound levels within the valve to increase between these positions due to the large amounts of water flowing through it! For optimum filtration benefits, always leave this valve in position A when the spa is covered and select positions B or C for maximum jet performance during spa use.*

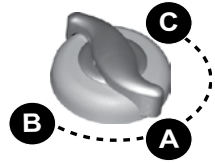

### 9.7 Air Controls

Certain jet systems have their own air control. Each control introduces air into the water lines that supply that specific jet group. Simply turn the air control of choice counterclockwise to open or clockwise to close. To minimize heat loss, all air controls should be closed when the spa is not in use.



## 10.0 Automatic Filtration Cycles

The control system activates a programmable “standard” or “economy” filtration cycle to remove debris from your spa. These cycles use the low speed pump and filter cartridge(s) to quickly clear “skim” the water of debris and minimize their “bathtub ring” affect while the spa is in use or during a programmed filter cycle. Models equipped with the optional 24-hour circulation pump offer the added benefit of 24-hour filtration for pennies a day!

Apart from their filtration benefit, each filtration mode also effects the operation of the spa heater. Refer to sections 10.1 and 10.2 on the following page for details.



### **10.1 Standard Filtration/Heating Modes For Models without Circulation Pump Option**

Standard filtration/heating modes (F1-F3) are typically selected by customers in cold climates where heat up times are extended due to lower ambient temperatures. In either of these modes, the water temperature is regulated by the set temperature, low-speed jets pump 1 and heater which turns on as needed. After the programmed set temperature is reached, the heater and low speed pump turn off, only to turn back on during a heat call or during the next programmed filtration/heating cycle.

### **10.2 Standard Filtration/Heating Modes For Models with Circulation Pump Option**

Standard filtration/heating modes (F0-F3) are typically selected by customers in cold climates where heat up times are extended due to lower ambient temperatures. In either of these modes, the water temperature is regulated by the set temperature, 24-hour circulation pump and heater which turns on as needed. After the programmed set temperature is reached, the heater turns off and the circulation pump continues to operate 24-hours to filter and clean your spa.

### **10.3 Economy Filtration/Heating Modes (All Models)**

Economy filtration/heating modes (F4-F6) are typically selected by customers in warm climates where heat up times are minimized due to higher ambient temperatures. In either of these modes, the water temperature is regulated by the set temperature, low-speed pump, and heater only while a programmed filtration/heating cycle is running. *Note: these modes can be used to conserve energy while on vacation or out of town for several weeks since heater operation is minimized. During such times, you can also minimize the spa set temperature to maximize energy savings!*

### **10.4 Lock Modes - All Models (L1 - L2)**

These modes are designed for use during spa service or to prevent unauthorized use.

### **10.5 Selecting The Filtration/Heating Mode**

Press and hold both control panel **WARMER ( + )** and **COOLER ( - )** buttons at the same time, then release. Then press either **WARMER ( + )** or **COOLER ( - )** button to select either filtration/heating mode or lock mode as outlined on pages 23 or 24.





## 10.6 Filtration Modes for Spas Without Circulation Pump Option

If your spa *is equipped* with the circulation pump option, disregard this section and refer to page 24 for filter cycle programming details.

### Standard Filtration/Heating Modes (F1 - F3)

(Heater automatically turns on during any heat call while in any Standard mode).

- F1** 4 hours of filtration per day (one 2-hour cycle every 12 hours).
- F2** 6 hours of filtration per day (one 2-hour cycle every 8 hours).
- F3** 8 hours of filtration per day (one 2-hour cycle every 6 hours).



### Economy Filtration/Heating Modes (F4 - F6)

(Heater can only turn on during an active filter cycle while in any economy mode).

- F4** 4 hours of filtration/heating per day (one 2-hour cycle every 12 hours).
- F5** 6 hours of filtration/heating per day (one 2-hour cycle every 8 hours).
- F6** 8 hours of filtration/heating per day (one 2-hour cycle every 6 hours).



### Lock Modes (L1 - L2)

- L1** Lock Out (disables all spa functions to permit filter cleaning).
- L2** Lock Mode (disables the jets and light buttons to prevent unauthorized use of spa). Filtration/heating cycle will continue to operate as programmed in this mode. The temperature display flashes when this function is enabled. Example: the “F3” filtration/heating cycle was enabled prior to choosing lock mode. The spa continues to perform the “F3” cycle until lock mode is canceled, allowing another cycle to be selected.



### Filter Cycle Setup Example

To set a time for the first filtration/heating cycle, simply turn power on to the spa two minutes prior to the desired time. **EXAMPLE:** If you desire your first filtration/heating cycle to begin at 10:00 AM turn off power to the spa and turn it back on again at 9:58 AM. *Note: start time is approximate and may vary slightly from day to day.*



## 10.7 Filtration Modes for Spas with Circulation Pump Option

If your spa is not equipped with the circulation pump option, disregard this section and refer to page 23 for filter cycle programming details.

### Standard Filtration/Heating Modes (F0 - F3)

(Heater automatically turns on during any heat call while in any Standard mode).

- F0** 5 minutes of filtration per day (one 5 minute “Blow-Out” cycle every 24 hours to purge all plumbing lines)
- F1** 1 hour of filtration per day (one 30-minute cycle every twelve hours); this is the factory default setting.
- F2** 1.5 hours of filtration per day (one 30-minute cycle every eight hours).
- F3** 2 hours of filtration per day (one 30-minute cycle every six hours).



### Economy Filtration/Heating Modes (F4 - F6)

(Heater can only turn on during an active filter cycle while in any economy mode).

- F4** 1 hour of filtration/heating per day (one 30-minute cycle every twelve hours).
- F5** 1.5 hours of filtration/heating per day (one 30-minute cycle every eight hours).
- F6** 2 hours of filtration/heating per day (one 30-minute cycle every six hours).



### Lock Modes (L1 - L2)

- L1** Lock Out (disables all spa functions to permit filter cleaning).
- L2** Lock Mode (disables the jets and light buttons to prevent unauthorized use of spa). Filtration/heating cycle will continue to operate as programmed in this mode. The temperature display flashes when this function is enable. Example: the “F3” filtration/heating cycle was enabled prior to choosing lock mode. The spa continues to perform the “F3” cycle until lock mode is canceled, allowing another cycle to be selected.



### Filter Cycle Setup Example

To set a time for the first filtration/heating cycle, simply turn power on to the spa two minutes prior to the desired time. EXAMPLE: If you desire your first filtration/heating cycle to begin at 10:00 AM turn off power to the spa and turn it back on again at 9:58 AM. *Note: start time is approximate and may vary slightly from day to day.*



## 11.0 Spa Maintenance

Regular maintenance of your spa will help it retain its beauty and performance. Your authorized Sundance dealer can supply you with all the information, supplies, and accessory products you will need to accomplish this.

### 11.1 Cleaning The Filter Cartridges

Your spa is equipped with two filter cartridges which are utilized as follows:

- Models equipped with the optional 24-hour circulation pump use cartridge 1 for the circulation pump and cartridge 2 for jets pump 1.
- Spas not equipped with the optional 24-hour circulation pump use both filter cartridges for jets pump 1.

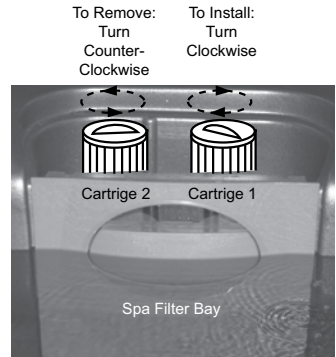

During spa use or an automatic filter cycle, water flows through the spa skimmer and into both polyester mesh filter cartridges to trap suspended particles and oils on their surface pleats. To ensure optimum performance, it is necessary to remove and clean both filter cartridges once a month or sooner depending on spa use and water quality.

Cleaning Procedure:

1. **Turn off power to the spa at the home's breaker panel or select the L1 "Lock Out" mode (page 23-24) to disable all spa functions.**
2. Remove filter lid from filter bay as shown, then remove each filter cartridge by rotating it counterclockwise and gently lifting upward after unthreading it from the mating wall fitting.
3. Using a garden hose and high pressure nozzle, rinse debris from each filter's outer pleats. Start at the top near the handle and work your way downward until all filter pleats on both filters are clean.  
Note: for simplicity, work on one section at a time until the entire filter surface is clean, then reinstall clean filters back into the spa finger tight!  
**DO NOT OVERTIGHTEN!**

Periodically, the filter cartridge will need a more thorough cleaning to remove imbedded oils and minerals. For this, we suggest performing steps 1-4 above, then soaking both cartridges overnight in a plastic container filled with a solution of water and a specially formulated filter cleanser available from your authorized Sundance dealer. The average



life expectancy of a Sundance filter cartridge is approximately two years with proper care and water quality maintenance. Replacement cartridges can be purchased from your authorized Sundance dealer.

## 11.2 Draining and Refilling

About every 3 months, you will want to replace the spa's water. The frequency depends on a number of variables including the amount of use, attention paid to water quality maintenance, etc. You will know it is time for a change when you cannot control sudsing and/or you can no longer get the normal feel or sparkle to the water even though the key water balance measurements are all within the proper parameters.



**WARNING! Read This Before Draining:** To prevent damage to the spa's components, **turn off power to the spa at the circuit breaker before draining it.** Do not turn the power back on until your spa has been refilled.



**CAUTION:** There are certain precautions to keep in mind when draining your spa. If it is extremely cold, and the spa is outdoors, freezing could occur in the lines or the equipment (see "WINTERIZING", 28). On the other hand, if it is hot outdoors, do not leave the spa's surface exposed to direct sunlight.

To drain your spa, perform the following steps:

1. Turn off power to spa at breaker.
2. Locate and remove the synthetic cabinet door screws and door. The door is located directly below the control panel and is easily identified by its vertical cooling slots.
3. Pull drain hose from equipment area (Figure-A)
4. Hold drain hose above water line, then unthread drain cap from hose using a counterclockwise rotation. Place drain hose on ground to start drain making sure to direct water away from spa (Figure B).
5. After spa has completely drained, reinstall drain cap on drain hose fitting by turning it clockwise until finger tight! **DO NOT OVERTIGHTEN!**

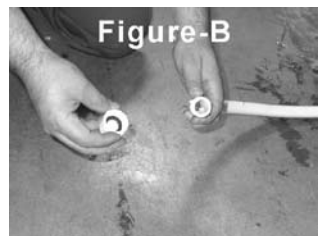
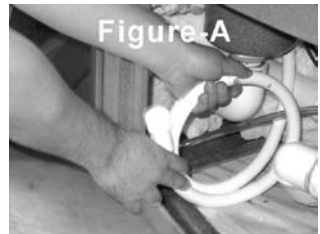



6. Coil drain hose up and place back inside the spa equipment bay (Figure-A).
7. Reinstall synthetic cabinet door and screws, then refer to the “Spa Fill Up Procedure” (page 12).

### 11.3 Pillow Care

Remove and clean each headrest by gently grasping both ends in each hand and pulling upward to release each pillow “snap.” To reinstall, simply “snap” each pillow back into place. Clean as needed with soapy water using a cloth or soft-bristle brush. To maintain water resistance and luster, apply a quality vinyl conditioner once a month. Always remove the pillows when adding chemical shock treatment to the spa water. The headrests can be returned to the spa when the sanitizer reading drops below 4 ppm.

### 11.4 Cleaning The Spa Interior

To preserve the sheen of your spa’s surface, it is crucial that you avoid using abrasive cleaners or cleaners which have adverse chemical effect on the surface. If you are not certain as to the suitability of a particular cleanser, consult your authorized Sundance dealer. Regardless of the cleanser used, use extreme care to assure that no soap residue is left on the surface. This could cause severe sudsing when the spa is refilled.

### 11.5 Maintaining the Cover

Using the Sundance insulating spa cover anytime the spa is not in use will significantly reduce your operating costs, heat-up time and maintenance requirements. To prolong the life of the cover, handle it with care and clean it regularly using mild soap and water. Periodic treatments with a special conditioner developed for Sundance spa covers will help protect against deterioration caused by UV rays from the sun. *Note: Never allow anyone to stand or sit on the cover, and avoid dragging it across rough surfaces.*

### 11.6 Maintaining The Synthetic Cabinet

Your new spa’s synthetic cabinet requires little or no maintenance of any kind. To clean, simply wipe cabinet with a clean towel and mild soap solution.



**CAUTION:** Never spray cabinet with a garden hose for any reason since this action may induce an electrical short in the spa’s electrical equipment.



## 11.7 Winterizing

Your Sundance® spa is designed to automatically protect itself against freezing when operating properly. During periods of severe freezing temperatures, you should check periodically to be certain that the electrical supply to the spa has not been interrupted. In extreme, bitter cold weather less than -20°F (-29°C), choose the F3 “Standard” filtration/heating mode to prevent freezing (pages 22-24).

If you do not intend to use your spa, or if there is a prolonged power outage during periods of severe freezing temperatures, it is important that all water be removed from the spa and equipment to protect against damage from freezing. **For expert winterization of your spa, contact your authorized Sundance dealer.** In emergency situations, damage can be minimized by taking the following steps:

1. Follow the directions on page 26-27 for draining the spa.
2. As the water level drops below the seats, use whatever means necessary to get the water out of the recessed seating areas and into the footwell.
3. When the water level ceases to drop, use whatever means available to remove any remaining water from the footwell.
4. *Turn off power to the spa.*
5. Remove the equipment-side cabinet panel and locate the drain plugs in the front of the pump(s) (Figure-A, page 11). Remove these plugs to allow the water to drain out of the pumps and heater. *Note: Approximately one to two gallons will be released during this procedure. Use a wet/dry vacuum or other means to keep this from flooding the equipment compartment. Replace the pump drain plugs.*
6. Re-install cabinet side panels and cover spa so that no casual moisture can enter into it.
7. Consult your authorized Sundance dealer if you have any questions regarding winter use or winterizing your spa.

## 11.8 Restarting Your Spa in Cold Weather

If you want to start up your spa after it has sat empty for a time in freezing temperatures, be aware that the water remaining in certain sections of the piping may still be frozen. This situation will block water flow preventing the spa from operating properly and possibly damaging the equipment. We recommend you consult your authorized Sundance dealer for guidance before attempting to re-start your spa under these conditions.



## 12.0 Water Quality Maintenance

Maintaining the quality of the water within specified limits will serve to enhance your enjoyment and prolong the life of the spa's equipment. It is a fairly simple task, but it requires regular attention because the water chemistry involved is a balance of several factors. There is no simple formula, and there is no avoiding it. A careless attitude in regard to water maintenance will result in poor and potentially unhealthful conditions for soaking and even damage to your spa. For specific guidance on maintaining water quality, consult your authorized Sundance dealer who can recommend appropriate chemical products for sanitizing and maintaining your spa.



**CAUTION:** *Never store spa chemicals inside the spa's equipment bay.*

### 12.1 pH Control

pH is a measure of relative acidity or alkalinity of water and is measured on a scale of 0 to 14. The midpoint of 7 is said to be neutral, above which is alkaline and below which is acidic. In spa water, IT IS VERY IMPORTANT TO MAINTAIN A SLIGHTLY ALKALINE CONDITION OF 7.4 to 7.6. Problems become proportionately severe the further outside of this range the water gets. A low pH will be corrosive to metals in the spa equipment. A high pH will cause minerals to deposit on the interior surface (scaling). In addition, the ability of the sanitation agents to keep the spa clean is severely affected as the pH moves beyond the ideal range. That is why almost all spa water test kits contain a measure for pH as well as sanitizer.

### 12.2 Sanitizing



**CAUTION:** Do not use chlorine tablets (trichlor) in your spa. This chemical can have an extremely corrosive effect on certain materials in the spa. Damage caused by use of this chemical, or improper use of any chemicals, is not covered under the spa's warranty.

To destroy bacteria and organic compounds in the spa water, a sanitizer must be used regularly. Chlorine and bromine are the two most popular sanitizers used to date. Many other additives are available for your spa. Some are necessary to compensate for out-of-balance water, some aid in cosmetic water treatment and others simply alter the feel or smell of the water. Your authorized Sundance dealer can advise you on the use of



these additives.

### 12.3 Optional CD Ozone Water Maintenance System

If you have elected to have your spa equipped with the optional Sundance CD ozone water purification system you will find that your water stays fresh and clear with significantly less chemical sanitizer usage. You will also probably be able to go longer between complete spa drainings.

## 13.0 Error Conditions / Error Messages

### 13.1 Summer Logic (Spas With Circulation Pump Option)

When the actual spa water temperature reaches up to 2 °F (1 °C) above the set temperature, the spa goes into “summer logic.” The 24-hour circulation pump will turn off automatically to avoid adding additional heat to the water, eventually creating an overheat condition. This setting is not user-programmable.



*Note: The summer logic does not take effect until the spa water temperature reaches 95°F (35°C). This condition is more likely in excessively hot weather. Remember, the spa’s ability to cool is directly affected by the ambient temperature. An excessively hot ambient temperature may prevent the spa from cooling down because it’s fully insulated construction is designed to retain heat and to minimize operating costs.*

### 13.2 Panel Displays OH

Water temperature is above acceptable limits. **DO NOT ENTER SPA!** Water temperature has reached 112°F (44°C) and the low speed pump and circulation pump (if equipped) have activated to circulate water through the heater.



### 13.3 Panel displays COL

Water temperature has dropped 20°F (11°C) below the current set temperature. Jets pump 1 and the heater have been activated to bring the temperature to within 15°F (8°C) of the set temperature. No corrective action is required! *Note: this condition is common during first time fillups or during refills since tap water is often very cold.*





### 13.4 Panel displays SN1

Open sensor (heater is disabled) or shorted sensor (spa is deactivated). The high-limit temperature sensor is not functioning. Your authorized Sundance dealer must repair this.



### 13.5 Panel displays SN2

Open or shorted sensor (heater disabled). The temperature sensor is not functioning. Your authorized Sundance dealer must repair this.



### 13.6 Panel Flashes FL1 or FL2 (Spas Without Circulation Pump Option)

A flashing "FL1" display means the pressure switch is not closed when the jets pump 1 is activated. Proper water flow is inhibited or the pressure switch has malfunctioned. A flashing "FL2" display means the pressure switch has malfunctioning closed. In either case, the heater is deactivated. To correct condition, perform the following:

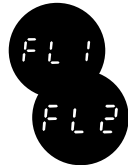

1. Verify water level is one inch below lowest pillow. Add water if necessary.
2. Check for clogged or excessively dirty filter cartridges (sec. 11.1, page 25).
3. Purge "air lock" from jets pump 1 by loosening the upper pump head drain screw (Figure-A, page 11) for a few seconds to release trapped air, then retighten drain screw. FINGER TIGHT ONLY!
4. If problem persists, contact your authorized Sundance dealer.

### 13.7 Panel Flashes FL1 or FL2 (Spas With Circulation Pump Option)

A flashing "FL1" display means the flow switch is malfunctioning open, the circulation pump filter cartridge 1 is excessively dirty or an "air lock" condition has occurred at the circulation pump intake. A flashing "FL2" display means the flow switch is malfunctioning closed. In either case, the spa heater will deactivate and jets pump #1 may also deactivate. To correct condition perform the following:

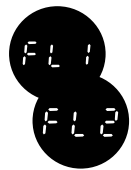

1. Verify water level is 1" below lowest pillow. Add water if necessary.
2. Check for clogged or excessively dirty filter cartridges (sec. 11.1, page 25).
3. Purge "air lock" from circulation pump intake by removing filter



cartridge 1. Hold your garden hose over the filter cartridge 1 wall fitting (with grate) while using a rag as a seal around hose end. Ask a helper to turn on water for 30 seconds, then turn off. Reinstall filter cartridge 1 and check spa (sec. 11.1, page 25).

4. If problem persists, contact your authorized Sundance dealer.

### 13.8 Panel Displays ICE

Freeze Protection - A potential freeze condition has been detected. No action is required. Jets pump 1, circulation pump (if equipped) and heater will operate to circulate and warm water through the plumbing spa is out of danger. See “Winterizing” section 11.7 for details (page 28).



### 13.9 Panel displays - - -

The safety “Watchdog” software has been triggered and the spa is deactivated. A problem has been detected which could cause damage to the spa or its components. Contact your authorized Sundance dealer.



## 14.0 Troubleshooting Procedures

In the event your spa is not working the way it should, please first review all the installation and operating instructions in this manual and check the message on the panel display. If you are still not satisfied it is working properly, please follow the appropriate troubleshooting instructions. *Note: If any of the supply cords to the accessories are damaged, they must be replaced by an authorized Sundance service technician.*

### 14.1 None Of The Components Operate (e.g. Pump, Light)

Check the following when none of the spa components operate (e.g. jets pumps or light):

1. Is there power to the spa?
2. Is the household circuit breaker tripped?
3. Contact your authorized Sundance dealer.

### 14.2 Pump Does Not Operate But Light Does

Press the JETS Button:

1. If no water movement is detected, make sure power is going to the spa and check the water level. If it does not solve the problem, contact your authorized Sundance dealer.
2. The main jets pump 1 operates but no water flows to jets. Check the following:



- Jets may all be closed in spa. Verify all jets are in the open “on” position (sec. 9.5, page 21).
- Pump may not be properly primed. This can happen after the spa is drained and refilled. Press the JETS 1 button on the control panel several times, never leaving the motor running for more than 5 to 10 seconds at a time. Turn power off and let the air out of spa plumbing system by removing both filter cartridges (sec. 11.1, page 25). Make certain you reinstall both filter cartridges before turning on spa power and restarting the jets pump 1.

### **14.3 Poor Jet Action**

1. Make sure jets are in the full open “on” position (page 21).
2. Press the JETS 1 button to make certain the pump #1 is on.
3. Open all air control to the “on” position (page 21).
4. Check for dirty filter (page 25). Clean, if necessary.

### **14.4 Water is Too Hot**

Reduce thermostat setting.

### **14.5 No Heat**

1. Check thermostat setting.
2. Keep the spa cover in place while heating.
3. Check the settings to see if your spa is in economy filtration/heating mode (page 22-24).

Should checking the above steps fail to correct the problem, please call your dealer so that they may arrange service.

We build the best spas in the industry. Nonetheless, we are always striving to improve the quality and features of our products. Your input as a Sundance spa owner is a cherished part of this process. If you have any comments or suggestions, or if you wish to be informed on any new products for your spa, please write to us.

**CONGRATULATIONS** on your good taste and welcome to the happiest and most relaxed family in the world!



# 16.0 Circuit Diagram For Models With Circulation Pump Option

This wiring diagram is used for all Hawthorne and Hartford 240V 60Hz North American spa models with the Circulation Pump Option.

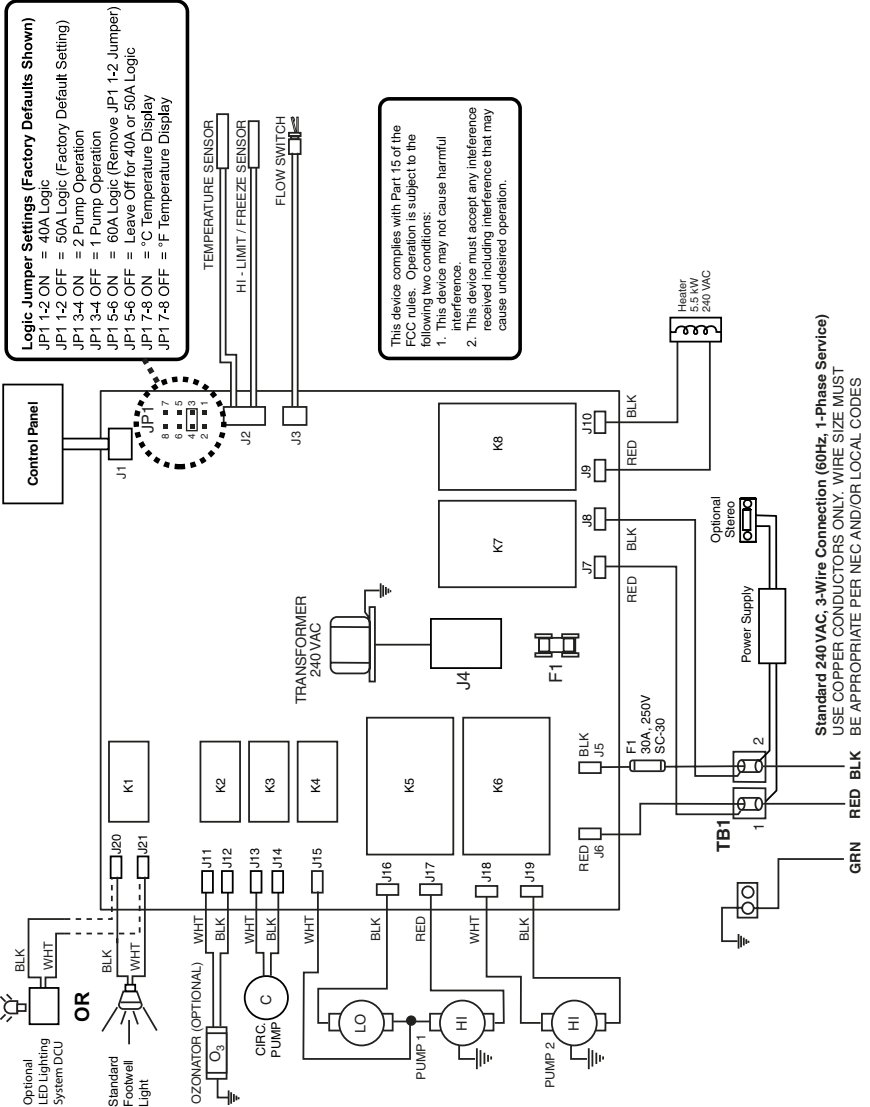



## 17.0 Optional SunSound™ Stereo Receiver Functions

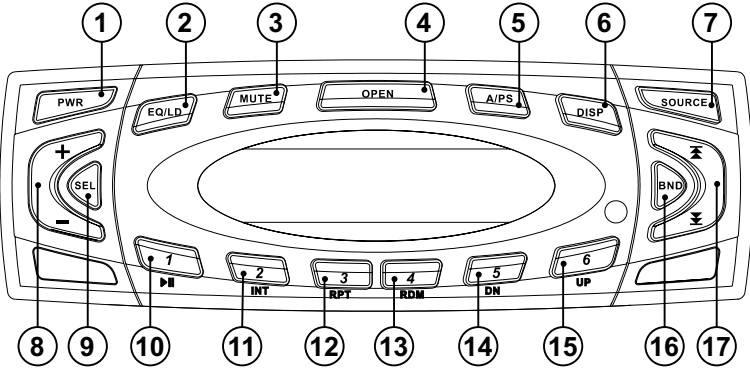

*To start enjoying your new Sundance SunSound Stereo Receiver, please read the following operation instructions in their entirety.*

- 1. Power Button:** Press PWR (Power) to turn deck on or off.
- 2. Equalization Button:** Repeatedly press EQ/LD to choose from DSP Off, Jazz, Pop, Classic, Rock or Vocal equalization options. Press and hold EQ/LD for 2 seconds to enable or disable the "LOUD" function.
- 3. Mute Button:** Press Mute to mute audio output. Press again to return to previous volume level.
- 4. Open Button:** Press Open to flip down the front access panel for CD access. Gently insert CD into slot (DO NOT FORCE!) Make sure to close the front panel to prevent damage to the unit.  
*Note: never insert a wet or moist CD since it may damage the mechanism and void the manufacturer warranty.*
- 5. A/PS Button:** Press A/PS to scan station presets. The tuner will scan up, wait for a few seconds, then continue. Once a desired station is found, press A/PS a second time to cancel scan. To automatically scan and store station presets, simply press and hold A/PS for several seconds, then release.
- 6. DISP Button:** Press DISP to switch between clock and station frequency. When selected, the clock will display for 5 seconds then automatically revert back to station frequency.

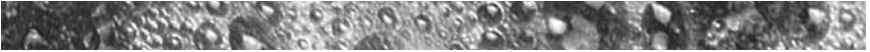

7. **Source Button:** Press Source to change input from audio or CD mode to auxiliary mode. Press a second time to switch back.
8. **Volume Buttons:** Press + (Volume Up) or - (Volume Down) to increase or decrease volume level.
9. **SEL Button:** Press SEL to choose control function:
  - 1) Bass
  - 2) Treble
  - 3) Balance
  - 4) Fader
  - 5) Volume

To adjust selection, press + (Volume Up) or - (Volume Down). Bass control: Adjusts the amount of low frequency. Treble control: Adjusts the amount of high frequency. Balance control adjusts the amount of sound output to the left and right speakers. Fader control adjusts the amount of sound output. You can decrease the sound level of the rear speakers by pressing + (Volume Up). To decrease the sound level of the front speakers press - (Volume Down). *Note: Bass and Treble settings are available only if EQ is set to DSP Off.*

10. **Preset 1/Pause Play Button:** In tuner mode, any station can be stored as preset 1 by pressing and holding this button for 2 seconds. To recall the station preset, simply press and release this button. In CD mode pressing this button will pause or play the CD.
11. **Preset 2/INT Button:** In tuner mode, any station can be stored as preset 2 by simply pressing and holding this button for 2 seconds. To recall the station preset, simply press and release this button. In CD mode pressing this button will preview each song on the disc for about 10 seconds. Simply press again to turn off this feature.
12. **Preset 3/RPT Button:** In tuner mode, any station can be stored as preset 3 by simply pressing and holding this button for several seconds. To recall the station preset, simply press and release this button. In CD mode pressing this button will play a song repeatedly. Press again to turn off this feature.

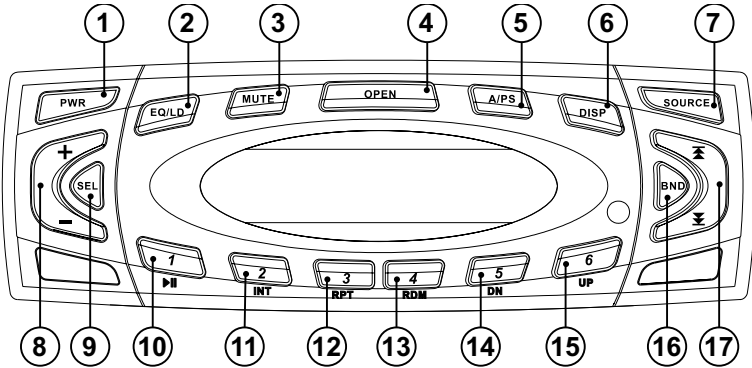

- 13. Preset 4/RDM Button:** In tuner mode, any station can be stored as preset 4 by simply pressing and holding this button for several seconds. To recall the station preset, simply press and release this button. In CD mode press this button to randomly play song tracks. Press again to turn off this feature.
- 14. Preset 5/DN Button:** In tuner mode, any station can be stored as preset 5 by simply pressing and holding this button for several seconds. To recall the station preset, simply press and release this button. In CD mode this button will browse the folders on CD-R and CD-RW disks.
- 15. Preset 6/UP Button:** In tuner mode, any station can be stored as preset 6 by simply pressing and holding this button for several seconds. To recall the station preset, simply press and release this button. In CD mode this button will browse the folders on CD-R and CD-RW disks.
- 16. BND Button:** Press BND to select one of the following frequency bands: FM1, FM2, FM3, AM1, AM2 and WB (weather band).
- 17. Tuning UP/DOWN Buttons:** Press Track Up to manually adjust station frequency up. Press and hold Track Up to scan for next higher station. Scan mode stops as soon as a strong station is found. Press Track Down to manually adjust frequency down. Press and hold Track Down to scan for next lower station. Scan mode stops as soon as a strong station is found. In CD mode pressing these buttons will advance the CD up or



down to the next or previous track. To fast forward or rewind through a track, simply press and hold either button as desired during CD playback.

18. **Reset Button** (Not Illustrated): If keys do not function at all and the unit appears to be "locked up", use a ballpoint pen to press the Reset Button under the front panel (press OPEN to flip down front panel for access). The Reset button is located directly below the Eject Button. Press to clear all memory (except station presets) and reset deck. *Note: this action will reset the display and clock to default settings.*
19. **Eject Button** (Not Illustrated): To eject CD, press OPEN and flip-down the front access panel, then press the Eject button located to the left of CD slot.
20. **USA/Europe Switch** (Not Illustrated): You can switch between American (USA) and European radio frequency bands by flipping a switch located on the bottom of the deck. To change bands:
  - 1) Power down unit
  - 2) Lift up sticker under the CD player.
  - 3) Choose desired frequency band as indicated on the sticker.
  - 4) Put sticker back in place and power up the unit.
21. **Setting The Clock (Unit Must be Off)**: To set the current time, press and hold Display (6) for 3 seconds until the clock display starts to blink, then set hours using the Track Up and/or Track Down button (17). Press Display a second time to set minutes, using the Track Up and/or Track Down buttons. Press and hold Display a third time to exit clock setup (or simply wait for 5 seconds).
22. **Selecting Weather Band Mode**: Press BND (16) while in tuner mode until WB displays (deck automatically skips to the strongest weather channel) or press BND a second time to return to previous mode. When WB weather band mode is active:
  - 1) Press Track Up (17) to scan to higher weather channel.
  - 2) Press Track Down (17) to scan to lower weather channel.
  - 3) To save a weather channel preset, press and hold one of six numeric keys 1-6. *Note: weather channel 7 is not accessible through preset key.*

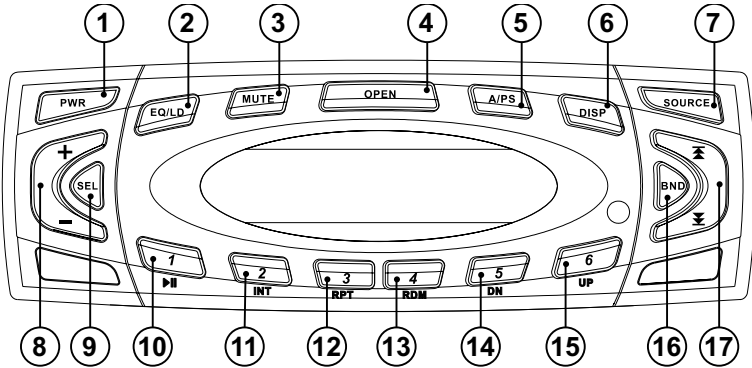

### 23. Display information DISP:

- When a retail music CD is inserted, press DISP (6) to change modes as follows:
  - 1) Clock (displays for 5 seconds only).
  - 2) CD track no. / Playtime
- When a CD containing MP3 files is inserted, press DISP (6) change modes as follows:
  - 1) Clock (displays for 5 seconds only).
  - 2) Track no. / Playtime
  - 3) Folder name
  - 4) File name
  - 5) Song name
  - 6) Artist's name
  - 7) Album name

The system can only display the first 8 letters of ID3 tags. If the recorded information is longer than 8 letters, text will scroll to the left once, then the 8 first letters will be displayed. If specific info has not been recorded on an MP3 disc, NO FOLD, NO TRK, NO TLT, NO ALBM, NO ART will display.

### 24. Playback Order of The MP3 File:

- 1) A directory that does not include an MP3 file is skipped.
- 2) We recommend that you make no more than two levels for each disc.
- 3) Maximum number of folders: 256
- 4) Maximum number of folder levels: 8
- 5) Maximum number of characters for MP3 file name and folder name: 32



- 6) Sampling frequency: 16 kHz, 22.05 kHz, 24 kHz, 32 kHz, 44.1 kHz, 48kHz
- 7) Bit rates: 8-320 Kbps
- 8) MP3 decoding format: MPEG 1 & 2 Audio Layer 3
- 9) Folder names and file names can be displayed with up to 8 characters (see Display key).
- 10) The characters A-Z, 0-9 can be displayed on this unit, other characters may not be displayed correctly.
- 11) ID3 tag is supported (see Display key).

**25. Reading files into a disc:** When a disc containing MP3 data is loaded, the unit checks all the data on the disc. If the disc contains numerous folders with many levels, it takes a longer time to start playback. In addition, it may take time for the unit to move to the next MP3 file and the fast forward function may not be performed smoothly. When selected to play, files and folders are accessed in order in which they were written by the CD writer. Therefore, the playing order may not be the same as the order in which they are expected. *For example, a disc with the following folder/file hierarchy is subject to folder select, file select and playback order as illustrated on page 42.*

### **Optional SunSound™ Audio Receiver Specifications**

- Marine Grade AM/FM/CD/CD-R/CD-RW/MP-3
- 7 Bands of Weather Band
- Stainless Steel Sealed Chassis and Mounting Hardware
- IPX5 Water Intrusion & CFR-46 Rated
- Conformal Coated Printed Circuit Boards
- ASTMB117 Salt Fog Tested 400 Hours
- ASTM D4329 UV Stable Tested 400 Hours
- Double Sealed Water Protection Transport Gaskets
- White Low Current / Low Heat LCD
- White Backlit Control Surfaces
- 5 Band Digital Sound Stage Settings
- 200 Watt, 50 x 4
- MP3 with ID-3 Tag, Video
- Switchable Tuner Frequency U.S. or Euro Band/CE Approved

### Example of a disc's folder/file hierarchy

Level 1 Level 2 Level 3 Level 4 Level 5

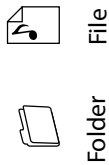
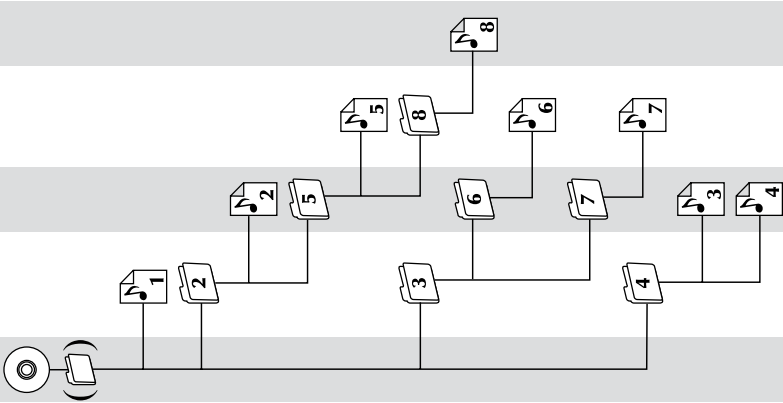

### Operation of the keys

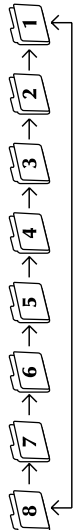
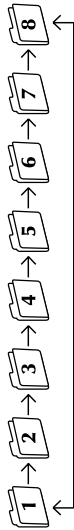

Press **⏴**(Track Down) to select folder down

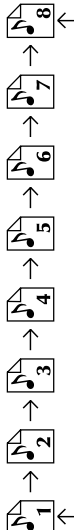

Press **⏵**(Track UP) to select folder up



Press and hold **5** **DN** to return 10 files behind.

Press and hold **6** **UP** to go 10 files forward.



**The following UL requirements must be observed for all spas with optional stereo components installed.**

- A. "CAUTION - Risk of Electric Shock. Do not leave compartment door open";
- B. "CAUTION - Risk of Electric Shock. Replace components only with identical components"; and
- C. Do not operate the audio/video controls while inside the spa."
- D. "WARNING - Prevent Electrocution. Do not connect any auxiliary components (for example: cable, additional speakers, headphones, additional audio/video components etc.) to the system."
- E. These units are not provided with an outdoor antennae; when provided, it should be installed in accordance with Article 810 of the National Electric Code, ANSI/NFPA 70.
- F. Do not service this product yourself as opening or removing covers may expose you to dangerous voltage or other risk of injury. Refer all servicing to qualified service personnel.
- G. When the power supply connections or power supply cord(s) are damage; if water is entering the audio/video compartment or any electrical equipment compartment area; if the protective shields or barriers are showing signs of deterioration; or if there are signs of other potential damage to the unit, turn off the unit and refer to a qualified service personnel.
- H. This unit should be subjected to periodic routing maintenance (for example, once every 3 months) to make sure that the unit is operating properly.

P/N: 6530-509, Rev. A

